

▶ CD710M  
KME761000B  
KME761000M  
KME761000W  
KMK761000M  
KMK761000W

KMM761000M  
KMR761000M  
KMR761000W  
KMS761000M

EN **User Manual**  
Microwave combi-oven

# USER MANUAL

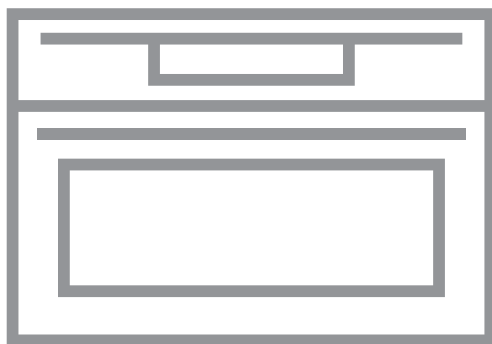

**AEG**

## CONTENTS

1. SAFETY INFORMATION.....	3
2. SAFETY INSTRUCTIONS.....	5
3. PRODUCT DESCRIPTION.....	8
4. CONTROL PANEL.....	9
5. BEFORE FIRST USE.....	11
6. DAILY USE.....	11
7. CLOCK FUNCTIONS.....	15
8. AUTOMATIC PROGRAMMES.....	16
9. USING THE ACCESSORIES.....	16
10. ADDITIONAL FUNCTIONS.....	17
11. HINTS AND TIPS.....	19
12. CARE AND CLEANING.....	37
13. TROUBLESHOOTING.....	38
14. TECHNICAL DATA.....	39
15. ENERGY EFFICIENCY.....	39

## FOR PERFECT RESULTS

Thank you for choosing this AEG product. We have created it to give you impeccable performance for many years, with innovative technologies that help make life simpler - features you might not find on ordinary appliances. Please spend a few minutes reading to get the very best from it.

Visit our website for:



Get usage advice, brochures, trouble shooter, service information:  
**[www.aeg.com/webselfservice](http://www.aeg.com/webselfservice)**



Register your product for better service:  
**[www.registeraeg.com](http://www.registeraeg.com)**



Buy Accessories, Consumables and Original spare parts for your appliance:  
**[www.aeg.com/shop](http://www.aeg.com/shop)**

## CUSTOMER CARE AND SERVICE

Always use original spare parts.

When contacting our Authorised Service Centre, ensure that you have the following data available: Model, PNC, Serial Number.

The information can be found on the rating plate.

 Warning / Caution-Safety information

 General information and tips

 Environmental information

Subject to change without notice.

## 1. SAFETY INFORMATION

Before the installation and use of the appliance, carefully read the supplied instructions. The manufacturer is not responsible for any injuries or damage that are the result of incorrect installation or usage. Always keep the instructions in a safe and accessible location for future reference.

### 1.1 Children and vulnerable people safety

- This appliance can be used by children aged from 8 years and above and persons with reduced physical, sensory or mental capabilities or lack of experience and knowledge if they have been given supervision or instruction concerning the use of the appliance in a safe way and understand the hazards involved.
- Children between 3 and 8 years of age and persons with very extensive and complex disabilities shall be kept away from the appliance unless continuously supervised.
- Children of less than 3 years of age should be kept away from the appliance unless continuously supervised.
- Do not let children play with the appliance.
- Keep all packaging away from children and dispose of it appropriately.
- Keep children and pets away from the appliance when it operates or when it cools down. Accessible parts may become hot during use.
- If the appliance has a child safety device, it should be activated.
- Children shall not carry out cleaning and user maintenance of the appliance without supervision.

### 1.2 General Safety

- Only a qualified person must install this appliance and replace the cable.

- **WARNING:** The appliance and its accessible parts become hot during use. Care should be taken to avoid touching heating elements.
- Always use oven gloves to remove or put in accessories or ovenware.
- Before carrying out any maintenance, disconnect the appliance from the power supply.
- **WARNING:** Ensure that the appliance is switched off before replacing the lamp to avoid the possibility of electric shock.
- Do not use the appliance before installing it in the built-in structure.
- Do not use a steam cleaner to clean the appliance.
- Do not use harsh abrasive cleaners or sharp metal scrapers to clean the glass door since they can scratch the surface, which may result in shattering of the glass.
- If the mains power supply cable is damaged, it must be replaced by the manufacturer, its Authorised Service Centre or similarly qualified persons to avoid an electrical hazard.
- Do not activate the appliance when it is empty. Metal parts inside the cavity can create electric arcing.
- Metallic containers for food and beverages are not allowed during microwave cooking. This requirement is not applicable if the manufacturer specifies size and shape of metallic containers suitable for microwave cooking.
- **WARNING:** If the door or door seals are damaged, the appliance must not be operated until it has been repaired by a qualified person.
- **WARNING:** Only a qualified person can carry out any service or repair operation that involves the removal of a cover which gives protection against exposure to microwave energy.
- **WARNING:** Do not heat liquids and other foods in sealed containers. They are liable to explode.
- Use only utensils that are suitable for use in microwave ovens.

- When heating food in plastic or paper containers, observe the appliance due to the possibility of ignition.
- The appliance is intended for heating food and beverages. Drying of food or clothing and heating of warming pads, slippers, sponges, damp cloth and similar may lead to risk of injury, ignition or fire.
- If smoke is emitted, switch off or unplug the appliance and keep the door closed in order to stifle any flames.
- Microwave heating of beverages can result in delayed eruptive boiling. Care must be taken when handling the container.
- The contents of feeding bottles and baby food jars shall be stirred or shaken and the temperature checked before consumption, in order to avoid burns.
- Eggs in their shell and whole hard-boiled eggs should not be heated in the appliance since they may explode, even after microwave heating has ended.
- The appliance should be cleaned regularly and any food deposits removed.
- Failure to maintain the appliance in a clean condition could lead to deterioration of the surface that could adversely affect the life of the appliance and possibly result in a hazardous situation.

## 2. SAFETY INSTRUCTIONS

### 2.1 Installation



#### **WARNING!**

Only a qualified person must install this appliance.

- Remove all the packaging.
- Do not install or use a damaged appliance.
- Follow the installation instructions supplied with the appliance.
- Always take care when moving the appliance as it is heavy. Always use safety gloves and enclosed footwear.
- Do not pull the appliance by the handle.
- Install the appliance in a safe and suitable place that meets installation requirements.
- Keep the minimum distance from other appliances and units.
- Before mounting the appliance, check if the oven door opens without restraint.
- The appliance is equipped with an electric cooling system. It must be operated with the electric power supply.
- The built-in unit must meet the stability requirements of DIN 68930.

Cabinet minimum height (Cabinet under the worktop minimum height)	444 (460) mm
Cabinet width	560 mm
Cabinet depth	550 (550) mm
Height of the front of the appliance	455 mm
Height of the back of the appliance	440 mm
Width of the front of the appliance	595 mm
Width of the back of the appliance	559 mm
Depth of the appliance	567 mm
Built in depth of the appliance	546 mm
Depth with open door	882 mm
Ventilation opening minimum size. Opening placed on the bottom rear side	560x20 mm
Mains supply cable length. Cable is placed in the right corner of the back side	1500 mm
Mounting screws	3.5x25 mm

## 2.2 Electrical connection



### **WARNING!**

Risk of fire and electric shock.

- All electrical connections should be made by a qualified electrician.
- The appliance must be earthed.
- Make sure that the parameters on the rating plate are compatible with the electrical ratings of the mains power supply.

- Always use a correctly installed shockproof socket.
- Do not use multi-plug adapters and extension cables.
- Make sure not to cause damage to the mains plug and to the mains cable. Should the mains cable need to be replaced, this must be carried out by our Authorised Service Centre.
- Do not let mains cables touch or come near the appliance door or the niche below the appliance, especially when it operates or the door is hot.
- The shock protection of live and insulated parts must be fastened in such a way that it cannot be removed without tools.
- Connect the mains plug to the mains socket only at the end of the installation. Make sure that there is access to the mains plug after the installation.
- If the mains socket is loose, do not connect the mains plug.
- Do not pull the mains cable to disconnect the appliance. Always pull the mains plug.
- Use only correct isolation devices: line protecting cut-outs, fuses (screw type fuses removed from the holder), earth leakage trips and contactors.
- The electrical installation must have an isolation device which lets you disconnect the appliance from the mains at all poles. The isolation device must have a contact opening width of minimum 3 mm.
- This appliance is supplied with a main plug and a main cable.

## 2.3 Use



### **WARNING!**

Risk of injury, burns and electric shock or explosion.

- This appliance is for household use only.
- Do not change the specification of this appliance.
- Make sure that the ventilation openings are not blocked.
- Do not let the appliance stay unattended during operation.
- Deactivate the appliance after each use.

- Be careful when you open the appliance door while the appliance is in operation. Hot air can release.
- Do not operate the appliance with wet hands or when it has contact with water.
- Do not apply pressure on the open door.
- Do not use the appliance as a work surface or as a storage surface.
- Open the appliance door carefully. The use of ingredients with alcohol can cause a mixture of alcohol and air.
- Do not let sparks or open flames to come in contact with the appliance when you open the door.
- Do not put flammable products or items that are wet with flammable products in, near or on the appliance.
- Do not use microwave function to preheat the oven.

**WARNING!**

Risk of damage to the appliance.

- To prevent damage or discoloration to the enamel:
  - do not put aluminium foil directly on the bottom of cavity of the appliance.
  - do not put water directly into the hot appliance.
  - do not keep moist dishes and food in the appliance after you finish the cooking.
  - be careful when you remove or install the accessories.
- Discoloration of the enamel or stainless steel has no effect on the performance of the appliance.
- Use a deep pan for moist cakes. Fruit juices cause stains that can be permanent.
- This appliance is for cooking purposes only. It must not be used for other purposes, for example room heating.
- Always cook with the oven door closed.
- If the appliance is installed behind a furniture panel (e.g. a door) make sure the door is never closed when the appliance operates. Heat and moisture can build up behind a closed furniture panel and cause subsequent damage to the appliance,

the housing unit or the floor. Do not close the furniture panel until the appliance has cooled down completely after use.

## 2.4 Care and cleaning

**WARNING!**

Risk of injury, fire, or damage to the appliance.

- Before maintenance, deactivate the appliance and disconnect the mains plug from the mains socket.
- Make sure the appliance is cold. There is the risk that the glass panels can break.
- Replace immediately the door glass panels when they are damaged. Contact the Authorised Service Centre.
- Be careful when you remove the door from the appliance. The door is heavy!
- Make sure the cavity and the door are wiped dry after each use. Steam produced during the operation of the appliance condensates on cavity walls and can cause corrosion.
- Clean regularly the appliance to prevent the deterioration of the surface material.
- Fat and food remaining in the appliance can cause fire and electric arcing when the microwave function operates.
- Clean the appliance with a moist soft cloth. Use only neutral detergents. Do not use abrasive products, abrasive cleaning pads, solvents or metal objects.
- If you use an oven spray, follow the safety instructions on its packaging.
- Do not clean the catalytic enamel (if applicable) with detergents.

## 2.5 Internal lighting

**WARNING!**

Risk of electric shock.

- The type of light bulb or halogen lamp used for this appliance is for household appliances only. Do not use it for house lighting.

- Before replacing the lamp, disconnect the appliance from the power supply.
- Use only lamps with the same specifications.

### 2.6 Service

- To repair the appliance contact the Authorised Service Centre.
- Use original spare parts only.

### 2.7 Disposal



**WARNING!**  
Risk of injury or suffocation.

- Disconnect the appliance from the mains supply.
- Cut off the mains electrical cable close to the appliance and dispose of it.
- Remove the door catch to prevent children or pets from becoming trapped in the appliance.

## 3. PRODUCT DESCRIPTION

### 3.1 General overview

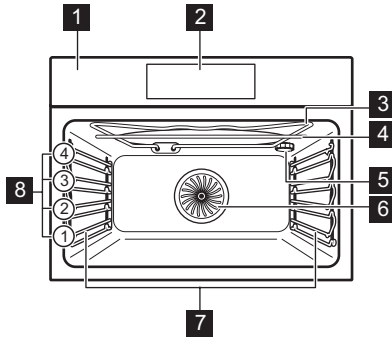

- 1 Control panel
- 2 Electronic programmer
- 3 Heating element
- 4 Microwave generator
- 5 Lamp
- 6 Fan
- 7 Shelf support, removable
- 8 Shelf positions

### 3.2 Accessories

#### Wire shelf

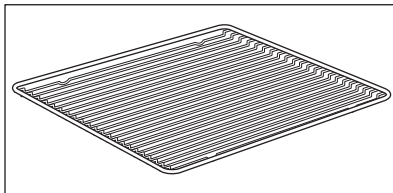

For cookware, cake tins, roasts.

#### Baking tray

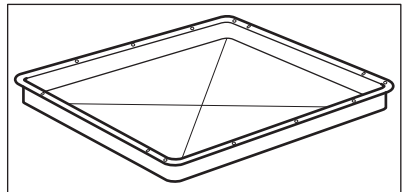

For cakes and biscuits.

#### Grill- / Roasting pan

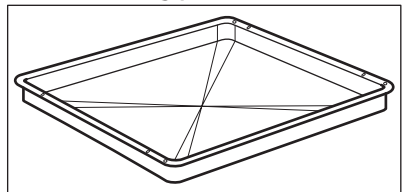









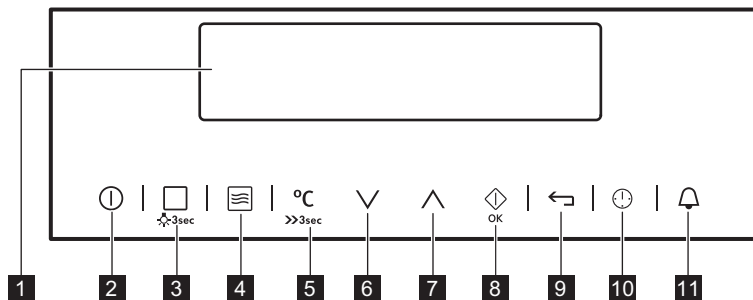

To bake and roast or as a pan to collect fat.



## 4. CONTROL PANEL

### 4.1 Electronic programmer

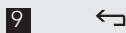

Use the sensor fields to operate the oven.

Sensor field	Function	Comment	
1	-	Display	Shows the current settings of the oven.
2		ON / OFF	To turn on and off the oven.
3		Heating Functions / Assisted Cooking	Press the sensor field once to choose a heating function or the menu: Assisted Cooking. Press the sensor field again to switch between the menus: Heating Functions, Assisted Cooking. To turn on or off the light, press the field for 3 seconds.
4		Microwave function	To turn on the: Microwave function. You can use it when the oven is off. When you use the: Microwave function with the function: Duration for more than 7 minutes and in Combi mode, the Microwave power cannot be more than 600 W.
5		Temperature selection / Fast Heat Up	To set the temperature or show the current temperature in the oven. Press the field for 3 seconds to turn on or off the function: Fast Heat Up.
6		Down	To move down in the menu.
7		Up	To move up in the menu.
8		OK / Microwave Quick Start	To confirm the selection or settings. To turn on the: Microwave function. You can use it when the oven is off.





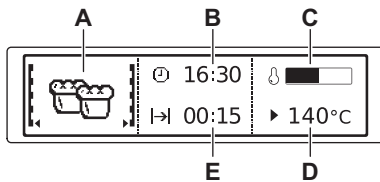





Sensor field	Function	Comment
	Back	To go back one level in the menu. To show the main menu, press the field for 3 seconds.
	Time and additional functions	To set different functions. When a heating function works, press the sensor field to set the timer or the functions: Function Lock, Favourites, Heat + Hold, Set + Go.
	Minute Minder	To set the function: Minute Minder.

## 4.2 Display



- A. Heating function or Microwave function
- B. Time of day
- C. Heat-up indicator
- D. Temperature or power of the microwave
- E. Duration time or end time of a function

Other indicators of the display:

Symbol	Function	Function
	Minute Minder	The function works.
	Time of day	The display shows the current time.
	Duration	The display shows the necessary time for cooking.
	End Time	The display shows when the cooking time is complete.
	Temperature	The display shows the temperature.
	Time Indication	The display shows how long the heating function works. Press  and  at the same time to reset the time.
	Heat-up Indicator	The display shows the temperature in the oven.
	Fast Heat Up	The function is on. It decreases the heat up time.
	Weight Automatic	The display shows that the automatic weight system is on or that weight can be changed.

Symbol	Function
	Heat + Hold The function is on.

## 5. BEFORE FIRST USE



**WARNING!**  
Refer to Safety chapters.

### 5.1 Initial Cleaning

Remove all accessories and removable shelf supports from the oven.

Refer to "Care and cleaning" chapter.

Clean the oven and the accessories before the first use.

Put the accessories and the removable shelf supports back to their initial position.

### 5.2 First Connection

When you connect the oven to the mains or after the power cut, you have to set the language, the display contrast, the display brightness and the time of the day.



1. Press  or  to set the value.
2. Press  to confirm.

## 6. DAILY USE



**WARNING!**  
Refer to Safety chapters.

### 6.1 Navigating the menus



1. Turn on the oven.
2. Press  or  to select the menu option.
3. Press  to move to the submenu or accept the setting.





At each point you can go back to the main menu with .



### 6.2 The menus in overview













Main menu

Symbol / Menu item	Application
 Heating Functions	Contains a list of heating functions.
 Assisted Cooking	Contains a list of automatic programmes.

Symbol / Menu item	Application
 Basic Settings	Used to set the appliance configuration.
 Favourites	Contains a list of favourite cooking programmes created by the user.
 Specials	Contains a list of additional heating functions.







Submenu for: Basic Settings

Symbol / Menu item	Description
 Set Time of Day	Sets the current time on the clock.
 Time Indication	When ON, the display shows the current time when you deactivate the appliance.

Symbol / Menu item	Description
 Fast Heat Up	When ON, the function decreases the heat-up time.
 Set + Go	To set a function and activate it later with a press of any symbol on the control panel.
 Heat + Hold	Keeps the prepared food warm for 30 minutes after a cooking cycle finished.
 Time Extension	Activates and deactivates the time extension function.
 Display Contrast	Adjusts the display contrast by degrees.
 Display Brightness	Adjusts the display brightness by degrees.
 Set Language	Sets the language for the display.
 Buzzer Volume	Adjusts the volume of press-tones and signals by degrees.
 Key Tones	Activates and deactivates the tone of the touch fields. It is not possible to deactivate the tone of the ON / OFF touch field.
 Alarm/Error Tones	Activates and deactivates the alarm tones.
 DEMO mode	Activation / deactivation code: 2468.
 Service	Shows the software version and configuration.





Symbol / Menu item	Description
 Factory Settings	Resets all settings to factory settings.



## 6.3 Heating Functions

Heating function	Application
 True Fan Cooking	To bake on up to two shelf positions at the same time and to dry food. Set the temperature 20 - 40 °C lower than for the function: Conventional Cooking.
 Pizza Function	To bake food on one shelf position for a more intensive browning and a crispy bottom. Set the temperature 20 - 40 °C lower than for the function: Conventional Cooking.
 Conventional Cooking	To bake and roast food on one shelf position.
 Frozen Foods	To make convenience food (e.g., french fries, potato wedges or spring rolls) crispy.
 Grill	To grill thin pieces of food and to toast bread.
 Turbo Grilling	To roast large meat joints or poultry with bones on one shelf position. To make gratins and to brown.
 Bottom Heat	To bake cakes with crispy bottom and to preserve food.



 The lamp may automatically deactivate at a temperature below 60 °C during some oven functions.

## 6.4 Specials

Heating function	Application
 Keep Warm	To keep food warm.
 Plate Warming	To preheat plates for serving.
 Preserving	To preserve vegetables (e.g., pickles).
 Dehydrating	To dry sliced fruit, vegetables and mushrooms.
 Dough Proving	To speed up the rising of the yeast dough. It prevents dough surface from drying and keeps the dough elastic.

Heating function	Application
 Slow Cooking	To prepare tender, succulent roasts.
 Bread Baking	Use this function to prepare bread and bread rolls with professional-like result in terms of crispiness, colour and crust gloss.
 Defrost	To defrost food (vegetables and fruit). The defrosting time depends on the amount and size of the frozen food.

## 6.5 Setting a heating function

1. Turn on the oven.
2. Select the menu: Heating Functions.
3. Press  to confirm.
4. Select a heating function.
5. Press  to confirm.
6. Set the temperature.
7. Press  to confirm.



## 6.6 Microwave functions



Functions	Description
Microwave	Creates the heat directly in the food. Use it to heat meals and drinks, to defrost meat or fruit, and to cook vegetables and fish.
Combi	Use it to operate the heating function and the microwave mode together. Use it to cook food in a shorter time and brown it. The maximum power for this function is 600 W.
Quick Start	Use it to turn on the Microwave function with one touch of the symbol  with the high microwave power and short operating time: 30 seconds.

## 6.7 Setting the Microwave function



1. Remove all accessories.
2. Turn on the oven.
3. Press  to turn on the Microwave function.



- Press . The function: Duration is set to 30 seconds and the microwave starts to operate.

 Each press of  adds 30 seconds to the time of the function: Duration.

 If you do not press , the oven turns off after 20 seconds.

- Press  to set the function: Duration.
- When the set time ends, a signal sounds for 2 minutes. The Microwave function turns off automatically. Press any symbol to stop the signal.

 To turn off the Microwave function, press .

 If you press  or open the door, the function stops. To start it again, press .

The maximum time of microwave functions depends on microwave power you set:

MICROWAVE POWER	MAXIMUM TIME
100 - 600 W	90 minutes
More than 600 W	7 minutes

## 6.8 Setting the Combi function



- Turn on a heating function.
- Press  and do the same steps as when you set the Microwave function.

When you use the Microwave function in Combi mode the Microwave power cannot be more than 600 W.

 For some functions the microwave will start as soon as the set temperature is reached.

Functions not available for the Combi function: Favourites, End Time, Set + Go, Heat + Hold.

## 6.9 Setting the Microwave Quick Start function

- If necessary, press  to turn off the oven.
- Press  to turn on the Quick Start function.

Each press of  adds 30 seconds to the Duration time.

 You can change the microwave power (refer to "Setting the Microwave function").

- Press  to set the time for the function: Duration. Refer to "Clock functions" chapter, Setting the clock functions.

## 6.10 Heat-up indicator

When you turn on a heating function, the bar on the display comes on. The bar shows that the temperature increases. When temperature is reached the buzzer sounds 3 times and the bar flashes and then disappears.

## 6.11 Fast Heat Up

This function decreases the heat-up time.

 Do not put food in the oven when the Fast heat up function works.

To turn on the function, hold  for 3 seconds. The heat-up indicator alternates.







This function is not available for some oven functions.

## 6.12 Residual heat

When you turn off the oven, the display shows the residual heat. You can use the heat to keep the food warm.

## 7. CLOCK FUNCTIONS

### 7.1 Clock functions table

Clock function	Application
 Minute Minder	To set a countdown (max. 2 h 30 min). This function has no effect on the operation of the oven. You can also turn it on when the oven is turned off. Use  to turn on the function. Press  or  to set the minutes and  to start.
 Duration	To set how long the oven works (max. 23 h 59 min).
 End Time	To set the switch-off time for a heating function (max. 23 h 59 min).

If you set the time for a clock function, the time starts to count down after 5 seconds.







If you use the clock functions: Duration, End Time, the oven turns off the heating elements after 90 % of the set time. The oven uses the residual heat to continue the cooking process until the time ends (3 - 20 minutes).

### 7.2 Setting the clock functions



Before you use the functions: Duration, End Time, you must set a heating function and temperature first. The oven turns off automatically.  
You can use the functions: Duration and End Time at the same time if you want to automatically turn on and turn off the oven on a given time later.

1. Set a heating function.
2. Press  again and again until the display shows the necessary clock function and the related symbol.
3. Press  or  to set the necessary time.
4. Press  to confirm.  
When the time ends, a signal sounds. The oven turns off. The display shows a message.
5. Press any symbol to stop the signal.



### 7.3 Heat + Hold

Conditions for the function:

- The set temperature is more than 80 °C.
- The function: Duration is set.

The function: Heat + Hold keeps prepared food warm at 80 °C for 30 minutes. It turns on after the baking or roasting procedure ends.

You can turn on or turn off the function in the menu: Basic Settings.

1. Turn on the oven.
2. Select the heating function.
3. Set the temperature above 80 °C.
4. Press  again and again until the display shows: Heat + Hold.
5. Press  to confirm.  
When the function ends, a signal sounds.

## 7.4 Time Extension

The function: Time Extension makes the heating function continue after the end of Duration.



Applicable to all heating functions with Duration or Weight Automatic.

1. When the cooking time ends, a signal sounds. Press any symbol. The display shows the message.
2. Press to turn on or to cancel.
3. Set the length of the function.
4. Press .

# 8. AUTOMATIC PROGRAMMES



**WARNING!**  
Refer to Safety chapters.

## 8.1 Recipes online

You can find the recipes for the automatic programmes on our website. To find the Recipe Book check the PNC number on the rating plate on the front frame of the oven cavity.

## 8.2 Assisted Cooking with Recipe Automatic

This oven has a set of recipes you can use. The recipes are fixed and you cannot change them.

1. Turn on the oven.
2. Select the menu: Assisted Cooking. Press to confirm.
3. Select the category and dish. Press to confirm.
4. Select a recipe. Press to confirm.



When you use the function: Manual, the oven uses the automatic settings. You can change them as with other functions.

## 8.3 VarioGuide with Weight Automatic

This function automatically calculates the cooking time. To use it, it is necessary to input the food weight.

1. Turn on the oven.
2. Select the menu: VarioGuide. Press .

3. Press or to set the food weight. Press .

The automatic programme starts.

4. You can change the weight at any time. Press or to change the weight.
5. When the time ends, a signal sounds. Press any symbol to turn off the signal.

# 9. USING THE ACCESSORIES



**WARNING!**  
Refer to Safety chapters.

## 9.1 Inserting the accessories

Use only suitable cookware and material.



**WARNING!**  
Refer to "Hints and tips" chapter, Microwave suitable cookware and materials.

Wire shelf:

Push the shelf between the guide bars of the shelf support and make sure that the feet point down.



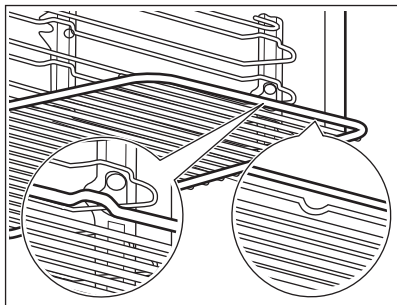

Baking tray/ Deep pan:

Push the baking tray / deep pan between the guide bars of the shelf support.

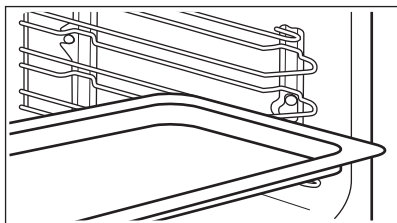

Wire shelf and baking tray / deep pan together:

Push the baking tray / deep pan between the guide bars of the shelf support and the wire shelf on the guide bars above.

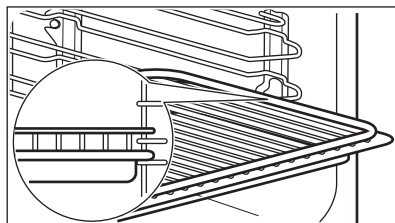

Small indentation at the top increase safety. The indentations are also anti-tip devices. The high rim around the shelf prevents cookware from slipping of the shelf.

## 10. ADDITIONAL FUNCTIONS

### 10.1 Favourites

You can save your favourite settings, such as duration, temperature or heating function. They are available in the menu: Favourites. You can save 20 programmes.



You cannot save Microwave and microwave combi functions as favourite programmes.

### Saving a programme

1. Turn on the oven.
2. Set a heating function or an automatic programme.
3. Press again and again until the display shows: SAVE.
4. Press to confirm. The display shows the first free memory position.
5. Press to confirm.
6. Enter the name of the programme. The first letter flashes.

7. Press or to change the letter.

8. Press .

The next letter flashes.

9. Do step 7 again as necessary.

10. Press and hold to save.

You can overwrite a memory position.

When the display shows the first free

memory position, press or and

press to overwrite an existing

programme.



You can change the name of a programme in the menu: Edit Programme Name.

### Activating the programme

1. Turn on the oven.
2. Select the menu: Favourites.
3. Press to confirm.
4. Select your favourite programme name.
5. Press to confirm.



## 10.2 Using the Child Lock



When the Child Lock is on, the oven cannot be turned on accidentally.

1. Press  to turn on the display.
2. Press  and  at the same time until the display shows a message .  
To turn off the Child Lock function repeat step 2.

## 10.3 Function Lock

This function prevents an accidental change of the heating function. You can turn it on only when the oven works.



1. Turn on the oven.
2. Set a heating function or setting.
3. Press  again and again until the display shows: Function Lock.
4. Press  to confirm.

To turn off the function, press . The display shows a message. Press  again and then  to confirm.

 When you turn off the oven, the function also turns off.

## 10.4 Set + Go

The function lets you set a heating function (or a programme) and use it later with one press of any symbol.

1. Turn on the oven.
2. Set a heating function.
3. Press  again and again until the display shows: Duration.
4. Set the time.
5. Press  again and again until the display shows: Set + Go.
6. Press  to confirm.

Press any symbol (except for ) to start the function: Set + Go. The set heating function starts.

When the heating function ends, a signal sounds.



- Function Lock is on when the heating function works.
- The menu: Basic Settings lets you turn the function: Set + Go on and off.

## 10.5 Automatic Switch-Off

For safety reasons the oven turns off automatically after some time, if a heating function works and you do not change any settings.

 (°C)	 (h)
30 - 115	12.5
120 - 195	8.5
200 - 230	5.5

The Automatic Switch-off does not work with the functions: Light, Duration, End Time.

## 10.6 Brightness of the display

There are two modes of display brightness:

- Night brightness - when the oven is turned off, the brightness of the display is lower between 10 PM and 6 AM.
- Day brightness:
  - when the oven is turned on.
  - if you touch a symbol during the night brightness (apart from ON / OFF), the display goes back to the day brightness mode for the next 10 seconds.
  - if the oven is turned off and you set the function: Minute Minder. When the function ends, the display goes back to the night brightness.

## 10.7 Cooling fan

When the oven operates, the cooling fan turns on automatically to keep the surfaces of the oven cool. If you turn off the oven, the cooling fan can continue to operate until the oven cools down.

## 11. HINTS AND TIPS



**WARNING!**  
Refer to Safety chapters.



The temperature and baking times in the tables are guidelines only. They depend on the recipes and the quality and quantity of the ingredients used.

### 11.1 Cooking recommendations

Your oven may bake or roast differently to the oven you had before. The tables below show recommended settings for temperature, cooking time and shelf position for specific types of the food.

If you cannot find the settings for a special recipe, look for the similar one.

### 11.2 Microwave recommendations

Place the food on a plate on the bottom of the cavity.

Turn or stir the food halfway through the defrosting and cooking time.

Cover the food for cooking and reheating.

Put the spoon to the bottle or glass when heating drinks to ensure better heat distribution.

Put the food into the oven without any packaging. The packaged ready meals

can be put into the oven only when the packaging is microwave safe (check information on the packaging).

#### Microwave cooking

Cook food covered. If you want to keep a crust cook food without a cover.

Do not overcook the dishes by setting the power and time too high. The food can dry out, burn or cause fire.

Do not use the oven to cook eggs or snails in their shells, because they can burst. Pierce the yolk of fried egg before reheating it.

Pierce food with skin or peel with a fork several times before cooking.

Cut vegetables into similar-sized pieces.

Stir liquid dishes from time to time.

Stir the food before serving.

After you turn off the oven, take the food out and let it stand for a few minutes.

#### Microwave defrosting

Put the frozen, unwrapped food on a small upturned plate with a container below it, or on a defrosting rack or plastic sieve so that the defrosting liquid can run off.

Remove defrosted pieces subsequently.

To cook fruit and vegetables without defrosting them first, you can use a higher microwave power.

### 11.3 Microwave suitable cookware and materials

For the microwave use only suitable cookware and materials. Use below table as a reference.

Cookware / Material	Microwave function		Microwave Combi function
	Defrosting	Heating, Cooking	
Ovenproof glass and porcelain with no metal components, e.g. heat-proof glass	✓	✓	✓

Cookware / Material	Microwave function		Microwave Combi function
	Defrosting	Heating, Cooking	
Non-ovenproof glass and porcelain without any silver, gold, platinum or other metal decorations	✓	X	X
Glass and glass ceramic made of ovenproof / frost-proof material	✓	✓	✓
Ceramic and earthenware without any quartz or metal components and glazes which contain metal	✓	✓	X
Ceramic, porcelain and earthenware with unglazed bottom or with small holes, e.g. on handles	X	X	X
Heat-resistant plastic up to 200 °C (please always check the plastic container specification before use)	✓	✓	X
Cardboard, paper	✓	X	X
Clingfilm	✓	X	X
Roasting film with microwave safe closure (please always check the film specification before use)	✓	✓	X
Roasting dishes made of metal, e.g. enamel, cast iron	X	X	✓
Baking tins, black lacquer or silicon-coated (please always check the baking tins specification before use)	X	X	✓
Baking tray	X	X	X
Wire shelf	X	X	✓
Cookware for microwave use, e.g. crisp pan	X	✓	X

## 11.4 Advice for special heating functions of the oven

### Keep Warm

The function allows you to keep food warm. The temperature is set automatically to 80 °C.

### Plate Warming

The function allows you to warm plates and dishes before serving. The temperature is set automatically to 70 °C.

Place plates and dishes in stacks evenly on the wire shelf. Use the first shelf position. After half of the warming time switch their places.

### Dough Proving

The function allows you to rise yeast dough. Put the dough into a big dish and cover it with a wet towel or plastic foil. Set function: Dough Proving and the cooking time.

### Defrost

Remove the food packaging and put the food on a plate. Do not cover the food, as it can extend the defrosting time. Use the first shelf position.

## 11.5 Baking

Use the lower temperature the first time.

You can extend baking times by 10 – 15 minutes if you bake cakes on more than one shelf position.







Cakes and pastries at different heights do not always brown equally. There is no need to change the temperature setting if an unequal browning occurs. The differences equalize during baking.







Trays in the oven can twist during baking. When the trays become cold again, the distortions disappear.

## 11.6 Tips on baking

Baking results	Possible cause	Remedy
The bottom of the cake is not baked sufficiently.	The shelf position is incorrect.	Put the cake on a lower shelf.
The cake sinks and becomes soggy or streaky.	The oven temperature is too high.	Next time set slightly lower oven temperature.
	The baking time is too short.	Next time set a longer baking time and lower oven temperature.
The cake is too dry.	The oven temperature is too low.	Next time set higher oven temperature.
	The baking time is too long.	Next time set shorter baking time.
The cake bakes unevenly.	The oven temperature is too high and the baking time is too short.	Set lower oven temperature and longer baking time.
	The cake batter is not evenly distributed.	Next time spread the cake batter evenly on the baking tray.
The cake is not ready in the baking time specified in a recipe.	The oven temperature is too low.	Next time set a slightly higher oven temperature.

## 11.7 Baking on one oven level

 <b>BAKING IN TINS</b>					
		 (°C)	 (min)		
Ring cake / Brioche	True Fan Cooking	150 - 160	50 - 70	1	
Madeira cake / Fruit cakes	True Fan Cooking	140 - 160	70 - 90	1	
Sponge cake	True Fan Cooking	140 - 150	35 - 50	1	
Sponge cake	Conventional Cooking	160	35 - 50	2	
Flan base - short pastry, preheat the empty oven	True Fan Cooking	170 - 180	10 - 25	1	
Flan base - sponge cake mixture	True Fan Cooking	150 - 170	20 - 25	1	
Apple pie, 2 tins Ø20 cm	True Fan Cooking	160	70 - 90	1	
Apple pie, 2 tins Ø20 cm	Conventional Cooking	180	70 - 90	1	
Cheesecake, use the deep pan	Conventional Cooking	160 - 170	60 - 90	1	

 <b>CAKE / PASTRIES / BREADS ON BAKING TRAYS</b>					
 <b>Preheat the empty oven.</b>					
		 (°C)	 (min)		
Plaited bread / Bread crown	Conventional Cooking	170 - 190	30 - 40	2	
Christstollen	Conventional Cooking	160 - 180	50 - 70	2	
Rye bread	Conventional Cooking	first: 230 then: 160 - 180	20 30 - 60	2	



## CAKE / PASTRIES / BREADS ON BAKING TRAYS



Preheat the empty oven.



(°C)



(min)



		(°C)	(min)	
Cream puffs / Eclairs	Conventional Cooking	190 - 210	20 - 35	2
Swiss roll	Conventional Cooking	180 - 200	10 - 20	2
Cake with crumble topping	True Fan Cooking	150 - 160	20 - 40	1
Buttered almond cake / Sugar cakes	Conventional Cooking	190 - 210	20 - 30	2
Fruit flans (made of yeast dough / sponge cake mixture)	True Fan Cooking	150 - 160	35 - 55	1
Fruit flans (made of yeast dough / sponge cake mixture)	Conventional Cooking	170	35 - 55	2
Fruit flans made of short pastry	True Fan Cooking	160 - 170	40 - 80	1
Yeast cakes with delicate toppings (e.g. quark, cream, custard)	Conventional Cooking	160 - 180	40 - 80	2



## BISCUITS









(°C)







(min)



		(°C)	(min)	
Short pastry biscuits	True Fan Cooking	150 - 160	10 - 20	1
Short bread / Pastry strips	True Fan Cooking	140	20 - 35	1
Short bread / Pastry strips, preheat the empty oven	Conventional Cooking	160	20 - 30	2

 <b>BISCUITS</b>				
		 (°C)	 (min)	
Biscuits made of sponge cake mixture	True Fan Cooking	150 - 160	15 - 20	1
Pastries made of egg white / Meringues	True Fan Cooking	80 - 100	120 - 150	1
Macaroons	True Fan Cooking	100 - 120	30 - 50	1
Biscuits made of yeast dough	True Fan Cooking	150 - 160	20 - 40	1
Puff pastries, preheat the empty oven	True Fan Cooking	170 - 180	20 - 30	1
Rolls, preheat the empty oven	Conventional Cooking	190 - 210	10 - 25	2
Small cakes, preheat the empty oven	True Fan Cooking	160	20 - 35	3
Small cakes, preheat the empty oven	Conventional Cooking	170	20 - 35	2

## 11.8 Bakes and gratins

 <b>Use the first shelf position.</b>				
		 (°C)	 (min)	
Pasta bake	Conventional Cooking	180 - 200	45 - 60	
Lasagne	Conventional Cooking	180 - 200	25 - 40	
Vegetables au gratin, preheat the empty oven	Turbo Grilling	210 - 230	10 - 20	
Baguettes with melted cheese	True Fan Cooking	160 - 170	15 - 30	
Milk rice	Conventional Cooking	180 - 200	40 - 60	
Fish bakes	Conventional Cooking	180 - 200	30 - 60	
Stuffed vegetables	True Fan Cooking	160 - 170	30 - 60	



## 11.9 Tips on Roasting

Use heat-resistant ovenware.

Roast lean meat covered.

Roast large meat joints directly in the tray or on the wire shelf placed above the tray.

Put some water in the tray to prevent dripping fat from burning.

Turn the roast after 1/2 - 2/3 of the cooking time.













Roast meat and fish in large pieces (1 kg or more).







Baste meat joints with their own juice several times during roasting.

## 11.10 Roasting tables







Use the first shelf position.

Set power for 200 W unless specified otherwise.







 <b>BEEF</b>				
			 (°C)	 (min)
Pot roast	1 - 1.5 kg	Conventional Cooking	230	60 - 80
 <b>PORK</b>				
 Use the function: Turbo Grilling.				
	 (kg)	 (°C)	 (min)	
Shoulder / Neck / Ham joint	1 - 1.5		160 - 180	50 - 70
Meatloaf	0.75 - 1		160 - 170	35 - 50
Pork knuckle, precooked	0.75 - 1		150 - 170	60 - 75







 VEAL				
 Use the function: Turbo Grilling.				
	 (kg)	 (°C)	 (min)	
Roast veal	1	160 - 180	50 - 70	
Veal knuckle	1.5 - 2	160 - 180	75 - 100	







  

 LAMB				
 Use the function: Turbo Grilling.				
	 (kg)	 (°C)	 (min)	
Lamb leg / Roast lamb	1 - 1.5	150 - 170	50 - 70	





  





 POULTRY				
 Use the function: Turbo Grilling.				
	 (kg)	 (°C)	 (min)	
Poultry, portions	0.2 - 0.25 each piece	200 - 220	20 - 35	
Chicken, half	0.4 - 0.5 each piece	190 - 210	25 - 40	
Chicken, poulard	1 - 1.5	190 - 210	30 - 45	
Duck	1.5 - 2	180 - 200	45 - 65	





 FISH				
	 (kg)		 (°C)	 (min)
Whole fish	1 - 1.5	Conventional Cooking	210 - 220	30 - 45

 DISHES				
 Use the function: True Fan Cooking.				
		 (W)	 (°C)	 (min)
Sweet dishes		200	160 - 180	20 - 35
Savoury dishes with cooked ingredients (noodles, vegetables)		400 - 600	160 - 180	20 - 45
Savoury dishes with raw ingredients (potatoes, vegetables)		400 - 600	160 - 180	30 - 45

## 11.11 Crispy baking with Pizza Function





 PIZZA		
 Use the third shelf position.		
	 (°C)	 (min)
Tarts	180 - 200	40 - 55
Spinach flan	160 - 180	45 - 60
Quiche lorraine	170 - 190	45 - 55
Swiss flan	170 - 190	45 - 55
Cheesecake	140 - 160	60 - 90

 PIZZA		
 Use the third shelf position.		
	 (°C)	 (min)
Apple pie, covered	150 - 170	50 - 60
Vegetable pie	160 - 180	50 - 60
Pizza, thin crust, preheat the empty oven	200 - 230	15 - 20

 <b>PIZZA</b>		
 <b>Use the third shelf position.</b>		
	 (°C)	 (min)
Pizza, thick crust, preheat the empty oven	180 - 200	20 - 30
Unleavened bread, preheat the empty oven	230	10 - 20
Puff pastry flan, preheat the empty oven	160 - 180	45 - 55
Flammkuchen, preheat the empty oven	230	12 - 20
Pierogi, preheat the empty oven	180 - 200	15 - 25

## 11.12 Bread Baking

Preheating is not recommended.





 <b>BREAD</b>		
 <b>Use the second shelf position.</b>		
	 (°C)	 (min)
White bread	180 - 200	40 - 60
Baguette	200 - 220	35 - 45
Brioche	160 - 180	40 - 60
Ciabatta	200 - 220	35 - 45
Rye bread	180 - 200	50 - 70
Wholemeal bread	180 - 200	50 - 70
Whole grain bread	170 - 190	60 - 90





## 11.13 Grill

Grill only thin pieces of meat or fish.

Preheat the empty oven before cooking.

Put a pan on the first shelf position to collect fat.

 <b>GRILL</b>			
 <b>Use the first shelf position.</b>			
	 (°C)	 (min)	
		<b>1st side</b>	<b>2nd side</b>
Roast beef, medium	210 - 230	30 - 40	30 - 40
Beef fillet, medium	230	20 - 30	20 - 30
Pork loin	210 - 230	30 - 40	30 - 40
Veal loin	210 - 230	30 - 40	30 - 40

 GRILL				
 Use the first shelf position.				
	 (°C)	 (min)		
			1st side	2nd side
Saddle of lamb	210 - 230	25 - 35	20 - 35	
Whole fish, 0.5 - 1 kg	210 - 230	15 - 30	15 - 30	





### 11.14 Slow Cooking

This function allows you to prepare lean, tender meat and fish. It is not applicable for: poultry, fatty roast pork, pot roast.

1. Sear the meat for 1 - 2 minutes on each side in a pan over high heat.
2. Put the meat in the roasting pan or directly on the wire shelf. Put a tray below the wire shelf to collect fat.

Always cook without a lid while using this function.

3. Select the function: Slow Cooking. You can set the temperature between 80 °C and 150 °C for the first 10 minutes. The default is 90 °C.
4. After 10 minutes, the oven automatically lowers the temperature to 80 °C.





 Use the first shelf position.					
	 (kg)	 (°C)	 (min)		
				Roast beef	1 - 1.5
Beef fillet	1 - 1.5	150	90 - 110		
Roast veal	1 - 1.5	150	120 - 150		
Steak	0.2 - 0.3	120	20 - 40		

### 11.15 Frozen Foods

Remove the food packaging. Put the food on a plate.

Do not cover the food, as this can extend the defrost time.

Use the second shelf position.





 DEFROSTING			
	 (°C)	 (min)	
Pizza, frozen	200 - 220	15 - 25	
Pizza American, frozen	190 - 210	20 - 25	
Pizza, chilled	210 - 230	13 - 25	
Pizza snacks, frozen	180 - 200	15 - 30	
French fries, thin, turn 2 or 3 times during cooking	210 - 230	20 - 30	
French fries, thick, turn 2 or 3 times during cooking	210 - 230	25 - 35	
Wedges / Croquettes, turn 2 or 3 times during cooking	210 - 230	20 - 35	
Hash browns	210 - 230	20 - 30	
Lasagne / Cannelloni, fresh	170 - 190	35 - 45	
Lasagne / Cannelloni, frozen	160 - 180	40 - 60	
Chicken wings	190 - 210	20 - 30	





### 11.16 Defrost

Remove the food packaging and put the food on a plate.

Use the first shelf position.

Do not cover the food, as this can extend the defrost time.

	 (kg)	 (min) Defrosting time	 (min) Further de- frosting time	
Chicken	1	100 - 140	20 - 30	Put the chicken on an upturned saucer in a big plate. Turn halfway through.
Meat	1	100 - 140	20 - 30	Turn halfway through.
Meat	0.5	90 - 120	20 - 30	Turn halfway through.
Trout	0.15	25 - 35	10 - 15	-
Strawberries	0.3	30 - 40	10 - 20	-

	 (kg)	 (min) Defrosting time	 (min) Further de- frosting time	
Butter	0.25	30 - 40	10 - 15	-
Cream	2 x 0.2	80 - 100	10 - 15	Whip the cream when still slightly frozen in places.
Gateau	1.4	60	60	-

## 11.17 Preserving

Use only preserve jars of the same dimensions available on the market.

Do not use jars with twist-off and bayonet type lids or metal tins.

Use the first shelf position.

Put no more than six one-litre preserve jars on the baking tray.



Fill the jars equally and close with a clamp.





The jars cannot touch each other.





Put approximately 1/2 litre of water into the baking tray to give sufficient moisture in the oven.

When the liquid in the jars starts to simmer (after approximately 35 - 60 minutes with one-litre jars), stop the oven or decrease the temperature to 100 °C (see the table).





Set the temperature to 160 - 170 °C.

	 (min) Cooking time un- til simmering
Strawberries / Blue-berries / Raspber-ries / Ripe gooseber-ries	35 - 45

	STONE FRUIT	
	 (min) Cooking time until simmering	 (min) Continue to cook at 100 °C
Peaches / Quinces / Plums	35 - 45	10 - 15

	VEGETABLES	
	 (min) Cooking time until simmering	 (min) Continue to cook at 100 °C
Carrots	50 - 60	5 - 10
Cucumbers	50 - 60	-
Mixed pickles	50 - 60	5 - 10
Kohlrabi / Peas / Aspar- agus	50 - 60	15 - 20





## 11.18 Dehydrating

 Use the third shelf position.		
	 (°C)	 (h)
Beans	60 - 70	6 - 8
Peppers	60 - 70	5 - 6
Vegetables for soup	60 - 70	5 - 6
Mushrooms	50 - 60	6 - 8
Herbs	40 - 50	2 - 3
Plums	60 - 70	8 - 10
Apricots	60 - 70	8 - 10
Apple slices	60 - 70	6 - 8
Pears	60 - 70	6 - 9





## 11.19 Microwave cooking





Tips for Microwave		
Cooking / Defrosting results	Possible cause	Remedy
The food is too dry.	Power was too high. Cooking time was too long.	Set lower power or/and shorter cooking time.
The food is not defrosted, cold or underdone after cooking time ends.	Cooking time was too short.	Set longer cooking time. Do not increase microwave power.
The food is overheated at the edges, but underdone in the middle.	Microwave power was too high.	Set lower power and longer cooking time.





### DEFROSTING





	 (kg)	 (min)	 Standing time (min)
Set power for 100 W unless specified otherwise.			
Steak	0.2	5 - 7	5 - 10
Minced meat, set 200 W	0.5	7 - 8	5 - 10













 <b>Set power for 100 W unless specified otherwise.</b>	 <b>(kg)</b>	 <b>(min)</b>	 <b>Standing time (min)</b>
Chicken	1	30 - 35	10 - 20
Chicken breast	0.15	5 - 9	10 - 15
Chicken legs	0.15	5 - 9	10 - 15
Whole fish	0.5	10 - 15	5 - 10
Fish fillet	0.5	12 - 15	5 - 10







 <b>Set power for 100 W.</b>	 <b>(kg)</b>	 <b>(min)</b>	 <b>Standing time (min)</b>
Butter	0.25	4 - 6	5 - 10
Grated cheese	0.2	2 - 4	10 - 15

 <b>Set power for 200 W unless specified otherwise.</b>	 <b>(kg)</b>	 <b>(min)</b>	 <b>Standing time (min)</b>
Yeast cake	1 piece	2 - 3	15 - 20
Cheesecake, set 100 W	1 piece	2 - 4	15 - 20
Dry cake	1 piece	2 - 4	15 - 20
Bread	1 kg	15 - 18	5 - 10
Sliced bread	0.2 kg	3 - 5	5 - 10
Bread rolls	4 pieces	2 - 4	2 - 5







 <b>(kg)</b>	 <b>(kg)</b>	 <b>(W)</b>	 <b>(min)</b>	 <b>Standing time (min)</b>
Fruit	0.25	100	5 - 10	10 - 15

 REHEATING		 POWER (W)	 (min)	 Standing time (min)
Baby food in jars	0.2 kg	300	1 - 2	-
Baby milk, put a spoon into the bottle	180 ml	600	0:20 - 0:40	-
Milk	200 ml	1000	1 - 1:30	-
Water	200 ml	1000	1:30 - 2	-
Sauce	200 ml	600	1 - 3	-
Soup	300 ml	600	3 - 5	-
Ready frozen meals	0.5 kg	400	10 - 15	2 - 5
Convenience food	0.5 kg	600	6 - 9	2 - 5

 MELTING	 (kg)	 POWER (W)	 (min)	 Standing time (min)
Chocolate / Chocolate icing	0.15	300	2 - 4	1 - 2
Butter	0.1	400	0:30 - 1:30	-

















 COOKING		 POWER (W)	 (min)	 Standing time (min)
				
Whole fish	0.5 kg	500	8 - 10	2 - 5
Fish fillet	0.5 kg	400	4 - 7	2 - 5
Vegetables, fresh	0.5 kg + 50 ml of water	600	5 - 15	-
Vegetables, frozen	0.5 kg + 50 ml of water	600	10 - 20	-
Jacket potatoes	0.5 kg	600	7 - 10	-
Rice	0.2 kg + 400 ml of water	600	15 - 18	-
Popcorn	-	1000	1:30 - 3	-

## Microwave Combi function

	 (kg)		 (W)	 (°C)	 (min)	 Stand- ing time (min)
Chicken, half, use the second shelf position	0.55 x 2 pieces	Round glass dish, Ø 26 cm	300	220	40	5
Au gratin potatoes, use the second shelf position	1	Round glass dish	300	200	40	10
Roast pork neck, use the first shelf position	1	Glass dish with strainer	300	200	70	10





## 11.20 Recommended power settings for different kinds of food







The data in the table is for guidance only.

700 - 1000 W				
 Cooking vegetables	 Searing at the start of the cooking process	 Heating liquids		
500 - 600 W				
 Cooking egg dishes	 Simmering stews	 Heating one-plate meals	 Defrosting and heating frozen meals	
300 - 400 W				
 Melting cheese, chocolate, butter	 Simmering rice	 Heating baby food	 Cooking / Heating delicate food	 Continuing cooking
100 - 200 W				
 Defrosting bread	 Defrosting fruit and cakes	 Defrosting cheese, cream, butter	 Defrosting meat, fish	

## 11.21 Information for test institutes

Tests according to IEC 60705.

Use wire shelf unless otherwise specified.					
MICROWAVE FUNCTION	 (W)	 (kg)		 (min)	
Sponge cake	600	0.475	Bottom	7 - 9	Turn container around by 1/4, halfway through the cooking time.
Meatloaf	400	0.9	2	25 - 32	Turn container around by 1/4, halfway through the cooking time.
Egg custard	500	1	Bottom	18	-
Meat defrosting	200	0.5	Bottom	7 - 8	Turn the meat upside down halfway through the cooking time.

Use the wire shelf.						
MICRO-WAVE COMBI FUNCTION		 (W)	 (°C)		 (min)	
Cake, 0.7 kg	True Fan Cooking + MW	100	180	2	29 - 31	Turn container around by 1/4, halfway through the cooking time.
Potato gratin, 1.1 kg	Turbo Grilling + MW	400	180	1	40 - 45	Turn container around by 1/4, halfway through the cooking time.
Chicken, 1.1 kg	Turbo Grilling + MW	200	200	1	45 - 55	Put the meat in round glass container and turn it upside down after 20 minutes of the cooking time.

## 12. CARE AND CLEANING



**WARNING!**  
Refer to Safety chapters.

### 12.1 Notes on cleaning



#### Cleaning Agents

Clean the front of the oven with a soft cloth with warm water and a mild cleaning agent.

To clean metal surfaces, use a dedicated cleaning agent.

Clean stubborn stains with a special oven cleaner.



#### Everyday Use

Clean the oven cavity after each use. Fat accumulation or other food remains may cause fire. The risk is higher for the grill pan.

Dry the cavity with a soft cloth after each use.

Clean the cavity ceiling carefully from food residuals and fat.



#### Accessories

Clean all accessories after each use and let them dry. Use a soft cloth with warm water and a cleaning agent. Do not clean the accessories in a dishwasher.

Do not clean the non-stick accessories using aggressive agents, sharp-edged objects or in a dishwasher.

### 12.2 How to remove: shelf supports

Before maintenance, make sure that the oven is cool. There is a risk of burns.

To clean the oven, remove the shelf supports.

1. Pull carefully the supports up and out of the front catch.

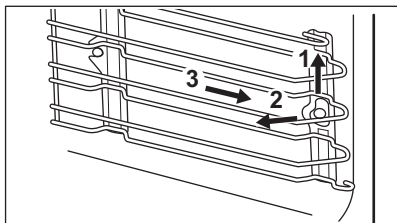

2. Pull the front end of the shelf support away from the side wall.
3. Pull the supports out of the rear catch.

Install the shelf supports in the opposite sequence.

### 12.3 How to replace: Lamp



**WARNING!**  
Risk of electric shock.  
The lamp can be hot.

1. Turn off the oven. Wait until the oven is cold.
2. Disconnect the oven from the mains.
3. Put a cloth on the bottom of the cavity.



**CAUTION!**  
Always hold the halogen lamp with a cloth to prevent grease residue from burning on the lamp.

## The top lamp

1. Turn the lamp glass cover to remove it.
2. Clean the glass cover.
3. Replace the lamp with a suitable 300 °C heat-resistant lamp.
4. Install the glass cover.

# 13. TROUBLESHOOTING



### WARNING!

Refer to Safety chapters.

## 13.1 What to do if...

Problem	Possible cause	Remedy
You cannot activate or operate the oven.	The oven is not connected to an electrical supply or it is connected incorrectly.	Check if the oven is correctly connected to the electrical supply (refer to the connection diagram if available).
The oven does not heat up.	The oven is turned off.	Turn on the oven.
The oven does not heat up.	The clock is not set.	Set the clock.
The oven does not heat up.	The necessary settings are not set.	Make sure that the settings are correct.
The oven does not heat up.	The automatic switch-off is on.	Refer to "Automatic switch-off".
The oven does not heat up.	The Child Lock is on.	Refer to "Using the Child Lock".
The oven does not heat up.	The fuse is blown.	Make sure that the fuse is the cause of the malfunction. If the fuse is blown again and again, contact a qualified electrician.
The lamp does not operate.	The lamp is defective.	Replace the lamp.
The display shows an error code that is not in this table.	There is an electrical fault.	<ul style="list-style-type: none"> <li>• Turn off the oven with the house fuse or the safety switch in the fuse box and turn it on again.</li> <li>• If the display shows the error code again, contact the Customer Care Department.</li> </ul>
Steam and condensation settle on the food and in the cavity of the oven.	You left the dish in the oven for too long.	Do not leave the dishes in the oven for longer than 15 - 20 minutes after the cooking process ends.

Problem	Possible cause	Remedy
The appliance is activated and does not heat up. The fan does not operate. The display shows " <b>Demo</b> ".	The demo mode is activated.	Refer to "Basic Settings" in "Daily use" chapter.

## 13.2 Service data

If you cannot find a solution to the problem yourself, contact your dealer or an Authorised Service Centre.

The necessary data for the service centre is on the rating plate. The rating plate is

on the front frame of the oven cavity. Do not remove the rating plate from the oven cavity.

We recommend that you write the data here:	
Model (MOD.)	.....
Product number (PNC)	.....
Serial number (S.N.)	.....

# 14. TECHNICAL DATA

## 14.1 Technical data

Voltage	220 - 240 V
Frequency	50 Hz

# 15. ENERGY EFFICIENCY

## 15.1 Energy saving



The oven contains features which help you save energy during everyday cooking.

Make sure that the oven door is closed properly when the oven operates. Do not open the door too often during cooking. Keep the door gasket clean and make sure it is well fixed in its position.

Use metal cookware to improve energy saving (only when you use a non-microwave function).

When possible, do not preheat the oven before cooking.

Keep breaks between baking as short as possible when you prepare a few dishes at one time.

### Cooking with fan

When possible, use the cooking functions with fan to save energy.

### Residual heat

If a programme with the Duration or End Time selection is activated and the cooking time is longer than 30 minutes, the heating elements automatically turn off earlier in some oven functions.

The fan and lamp continue to operate. When you turn off the oven, the display shows the residual heat. You can use that heat to keep the food warm.

When the cooking duration is longer than 30 minutes, reduce the oven temperature to minimum 3 - 10 minutes before the end of cooking. The residual heat inside the oven will continue to cook.

Use the residual heat to warm up other dishes.

#### **Keep food warm**

Choose the lowest possible temperature setting to use residual heat and keep a

meal warm. The residual heat indicator or temperature appears on the display.

#### **Cooking with the lamp off**

Turn off the lamp during cooking. Turn it on only when you need it.

## 16. ENVIRONMENTAL CONCERNS

Recycle materials with the symbol . Put the packaging in relevant containers to recycle it. Help protect the environment and human health by recycling waste of electrical and electronic appliances. Do not dispose of

appliances marked with the symbol  with the household waste. Return the product to your local recycling facility or contact your municipal office.









[www.aeg.com/shop](http://www.aeg.com/shop)



867300539-E-342019



**AEG**